

Assembly Instructions

Dion Series

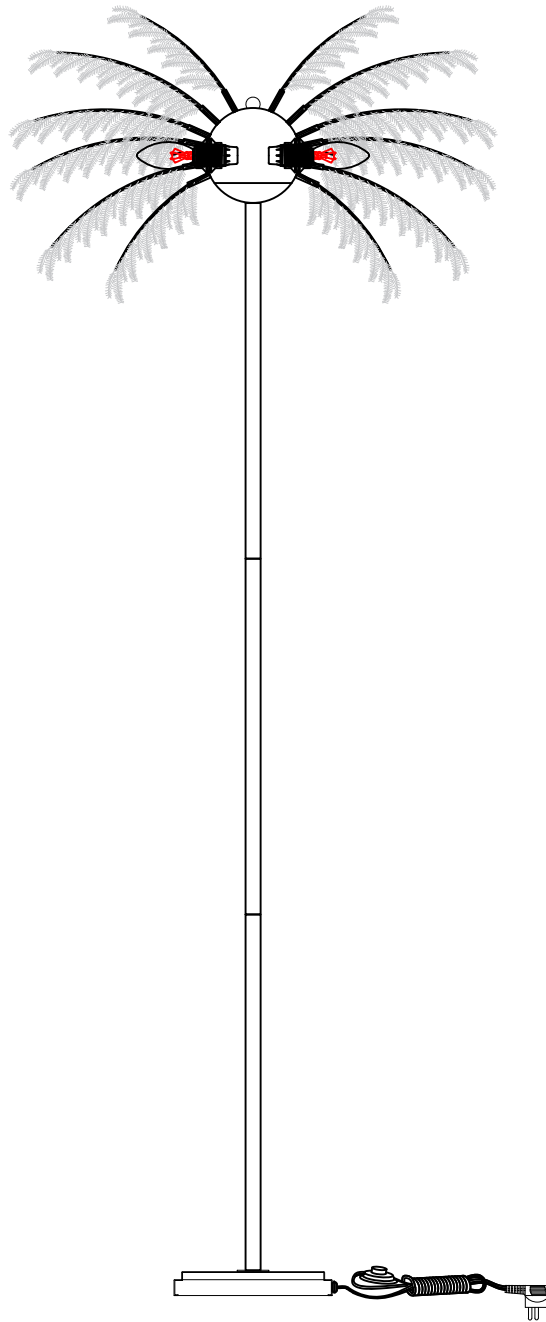

Lifely*

Product Code

DION-FLAMP Dion Ostrich Feather Floor Lamp

Dimensions (W x D x H)

600*600*1600mm

Important

Please read through instruction carefully
Before assembly and keep for future reference.

For our full catalogue of assembly instructions,
Visit: lifely.com.au/assembly.

IMPORTANT SAFETY INSTRUCTIONS:

1. Use an authorized and certified electrician for consultation and installation.
2. To avoid the risk of fire, do not exceed the recommended wattage.
Use 220-240V~50/60 Hz 3 x Max. 40 W or LED Max. 5 W E14 Bulb.
3. The manufacturer and distributor accepts no liability for incorrect installation.
4. For indoor use only.
5. Keep away from children.
6. To avoid electric shock, fire, or injury, do not use it if any breakage or distortion is found on the wire or socket, or if the products got wet.

Warnings:

1. Turn-off electricity supply at main circuit panel before installing. Do not connect electricity supply until your floor lamp is fully assembled and installed.
2. All wires are connected. Do not remove the floor lamp from its packaging by pulling on the power cord, as a bad connection may result.
3. To reduce the risk of fire, electrical shock, or personal injury, always turn off the floor lamp and allow it to cool prior to replacing light bulb. Do not touch bulb when fixture is turned on or look directly at light bulb. Keep flammable materials away from light bulb.
4. Deviation from instructions may result in a risk of fire or electric shock.

CARE INSTRUCTIONS:

1. Make sure that the power is turned off and bulb has cooled before handling.
2. Wipe clean with a dry cloth / mild soapy solution. Do not use corrosive cleaners.
3. If the external flexible cable or cord of this luminaire is damaged, it shall be exclusively replaced by the manufacturer or his service agent or a similar qualified person in order to avoid a hazard

ENVIRONMENT:

Special waste handling may be required. Please contact your local authorities for more information.

Important Tips and Maintenance

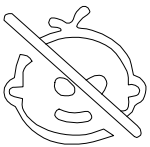

1. Keep children and animals away from working area as smaller parts may cause choking if swallowed.

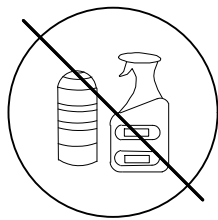

2. Never use ammonia based cleaning products as it will damage the finish.

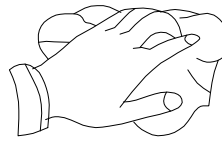

3. Use a soft dry cloth when wiping or cleaning surfaces.

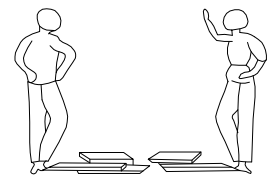

4. Two person are required.

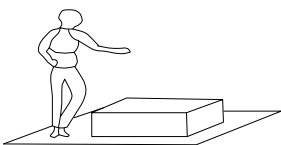

5. Lay a soft matt down to protect the fixture piece before and during assembly.

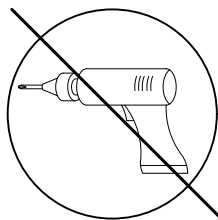

6. NO POWER TOOLS

So your relationship is strong. But is it flat-pack furniture strong? Unless you're an aerospace engineer, assembling furniture can be slightly stressful. We recommend meditating quietly, pouring yourself a herbal tea (or slightly less herbal wine) and tackling things one step at a time. If you feel a passive aggressive remark coming on, try a compliment instead. E.g. "You're so good looking."

This 4-step assembly should take around 18 minutes.

Designed for everyday

Component Hardware

Please check you have all the fittings
part or tools are listed in below.

No. A (Not Included)

Quantity:3 Pcs

E14 Bulbs

φ 33*98mm



No. B

Quantity:65 Pcs (3 of them are spare parts)

ostrich feather

150*330mm



Component Panels & part List

Please check you have all the panels
are listed below.

1. Lamp feather holder ----- x1
2. Steel tube ----- x3
3. Base ----- x1

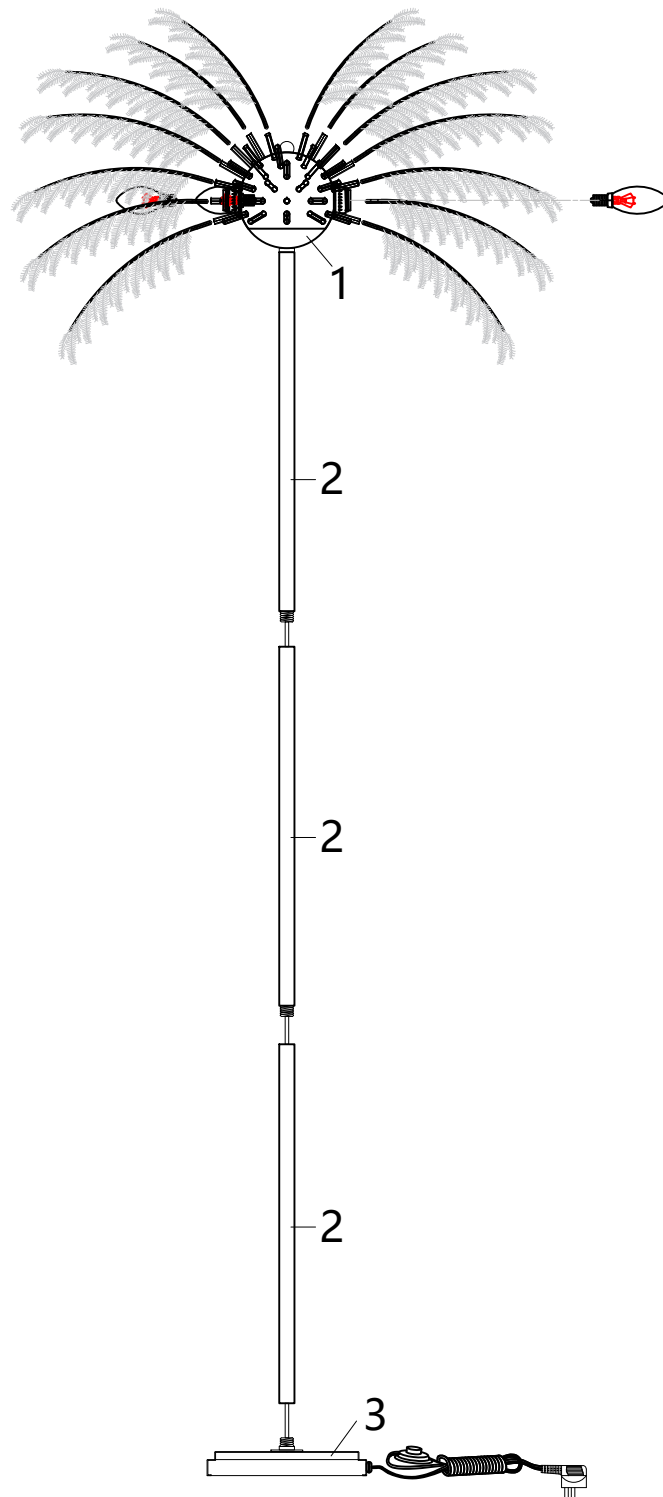

STEP 1

Screw 1 and 2 first, then screw between parts 2.

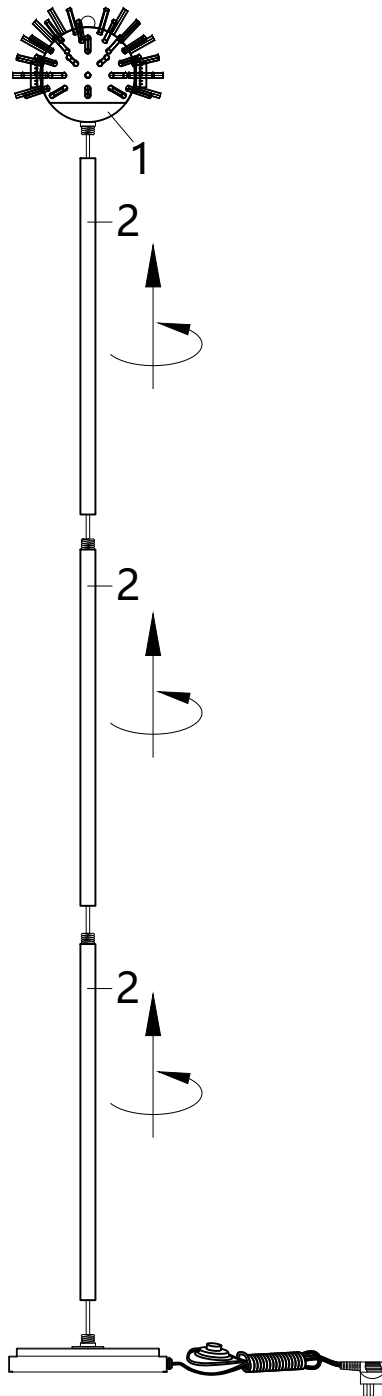

STEP 2

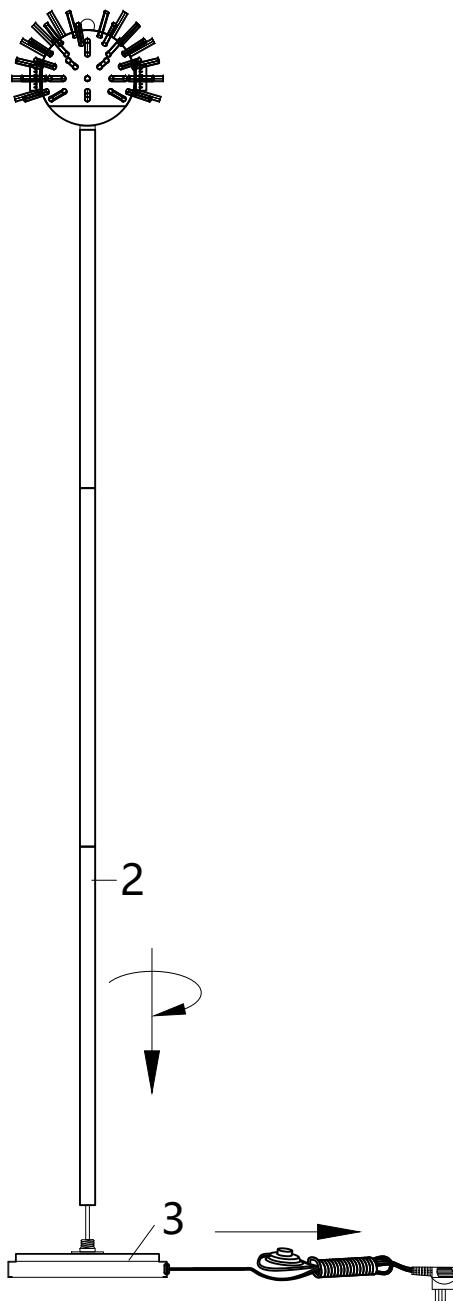

Pull out the supply cord a bit, then screw the part 2 and Base 3.

STEP 3

please note that there are 12 pieces feathers whoes head is bigger, they are suggested to been inserted in the bottom circle 12 feather holders, so that the feather will not fall off easily.

if other feathers easy to fall off after long time using, please punch the head of feather from round to flat so that it can inserted tighten in the feather holder.

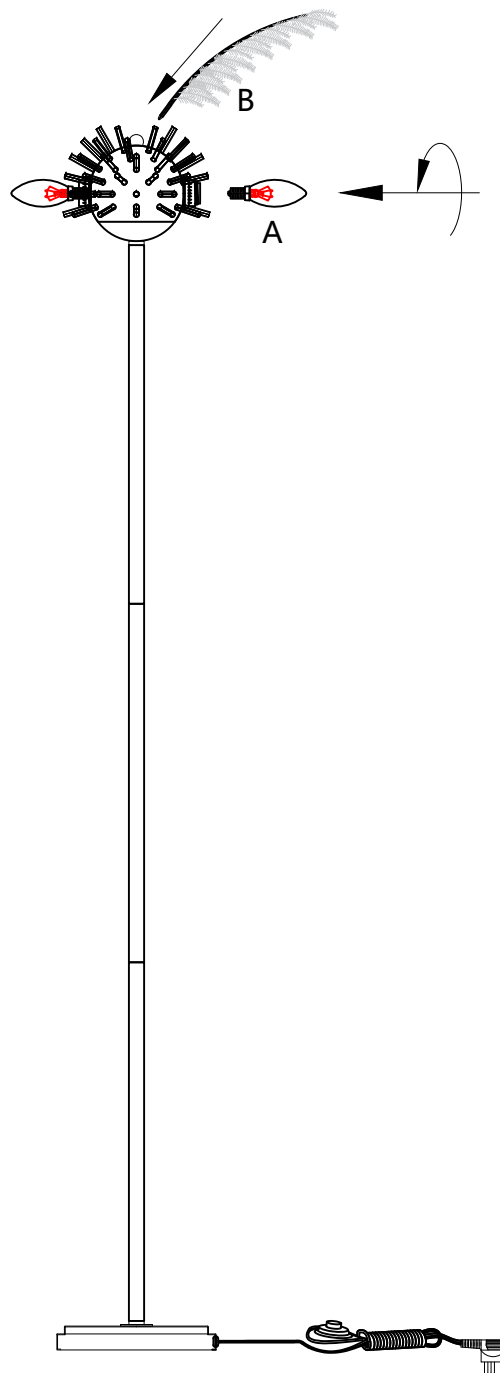

STEP 4

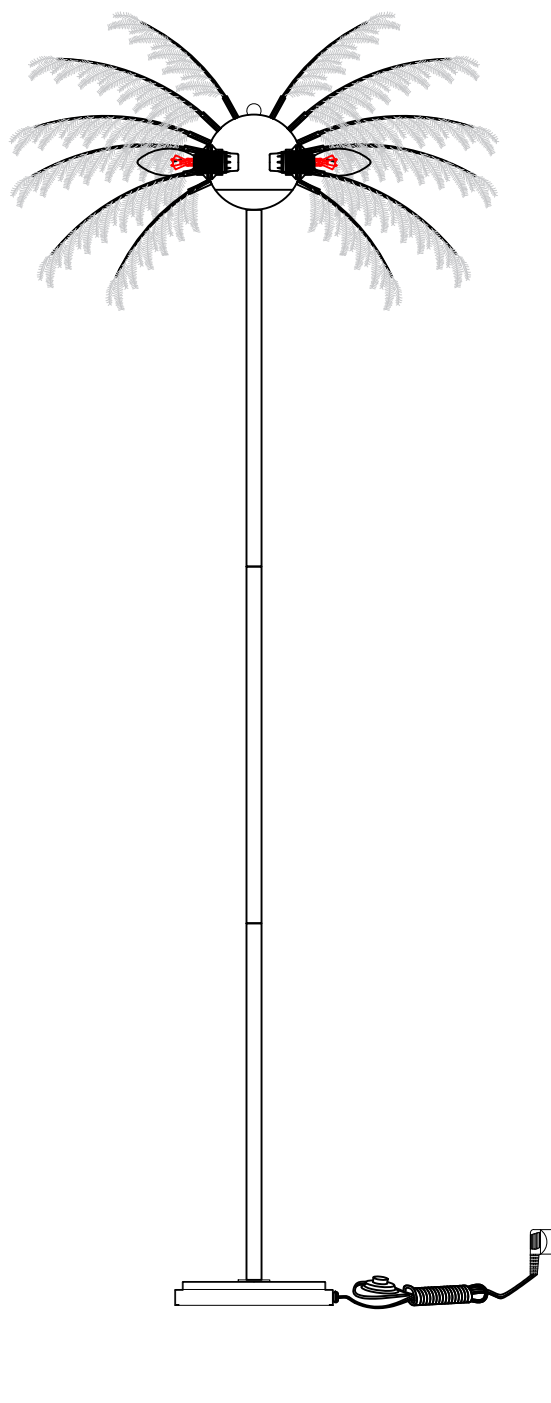

Great job. You're done!

Don't forget to share how it looks in
your space and tag us on Instagram.

@lifelyhome #homewithlifely!