

Assembly Instructions

Sorrento Series

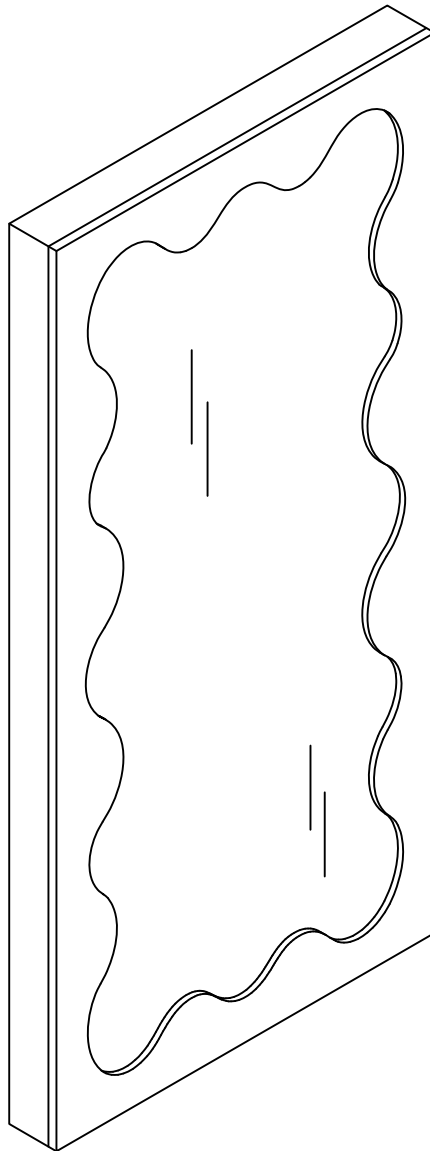

Lifely*

Product Code

SRT-MR80-WHT Sorrento Mirror

Dimensions(W x D x H)

800*100*1650mm

Important

Please read through instruction carefully
Before assembly and keep for future reference.

For our full catalogue of assembly instructions,
Visit: lifely.com.au/assembly.

Important Tips and Maintenance

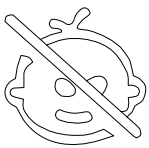

1. Keep children and animals away from working area as smaller parts may cause choking if swallowed.

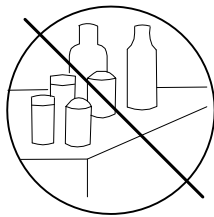

2. Never place liquids or anything damp upon furniture as it will mark. Ensure a coaster or running is beneath.

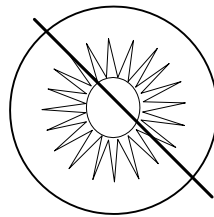

3. Never use ammonia based cleaning products as it will damage the finish.



4. To avoid fading, keep furniture out of direct sunlight.

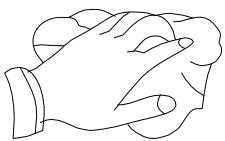

5. Use a soft or damp cloth (dry cloth) when wiping or cleaning surfaces.

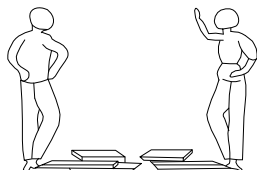

6. Two person are required.

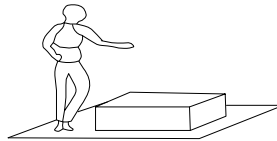

7. Lay a soft matt down to protect the furniture piece before and during assembly.

So your relationship is strong. But is it flat-pack furniture strong? Unless you're an aerospace engineer, assembling furniture can be slightly stressful. We recommend meditating quietly, pouring yourself a herbal tea (or slightly less herbal wine) and tackling things one step at a time. If you feel a passive aggressive remark coming on, try a compliment instead. E.g. "You're so good looking."

This 3-step assembly should take around 20 minutes.

Designed for everyday

Component Hardware

Please check you have all the fittings
part or tools are listed in below.

No. A
Quantity:1 Set
Anti - dumping
L=250mm

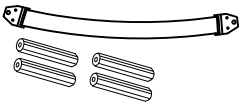

No. B
Quantity:2 Sets
Screw
 $\phi 4 \times 16\text{mm}$



No. C
Quantity:4 Sets
Screw
 $\phi 4 \times 25\text{mm}$



No. D
Quantity:2 Pcs
Angle iron



No. E
Quantity:1 Pc
Key
5mm



No. F
Quantity:1 Pair
Gloves



Component Panels & Part List

Please check you have all the panels are listed below.

- 1. Mirror - - - - - x1

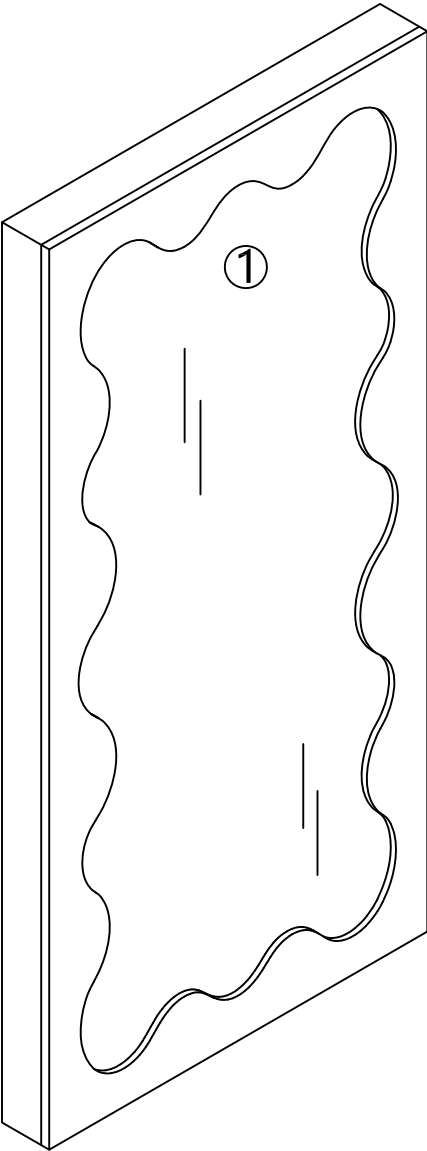

OPTION 1:

STEP 1

WALL

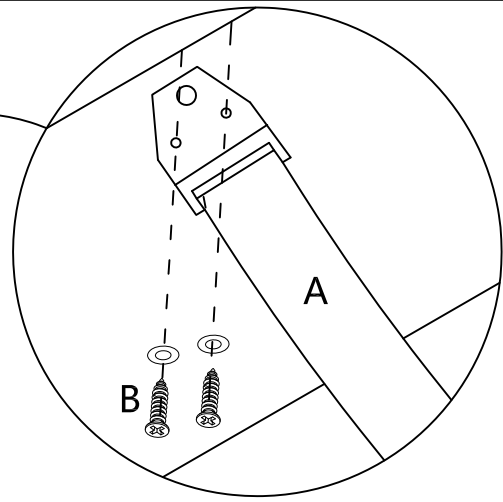
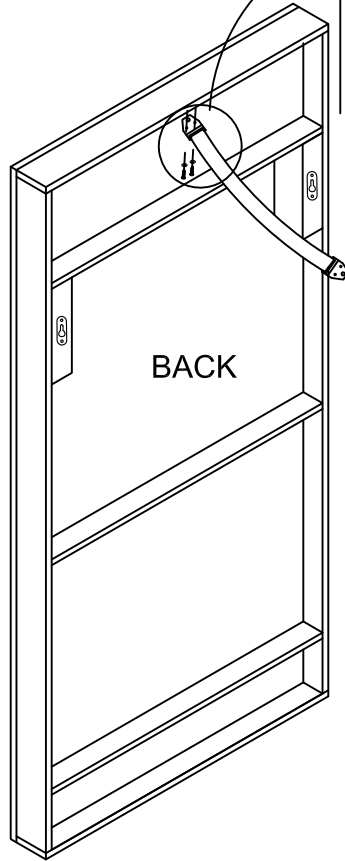

No. A
Quantity:1 Pc

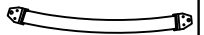

No. B
Quantity:2 Sets



STEP 2

WALL

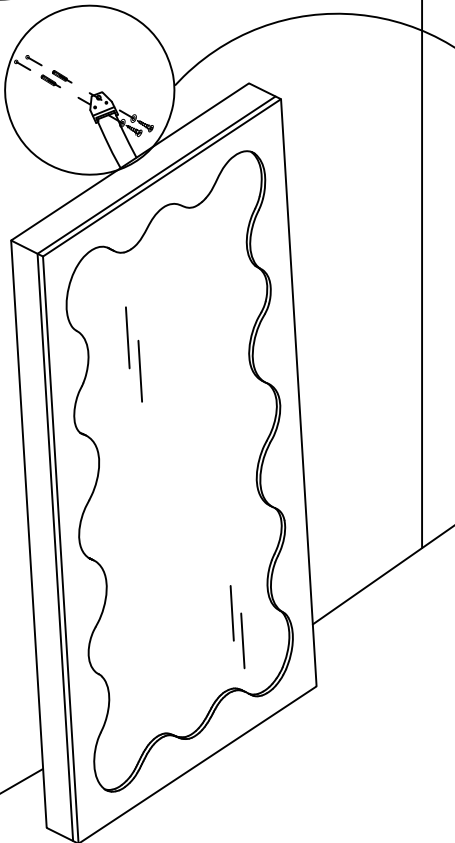

DRILL HOLE OF $\varnothing 6$ x
D35mm

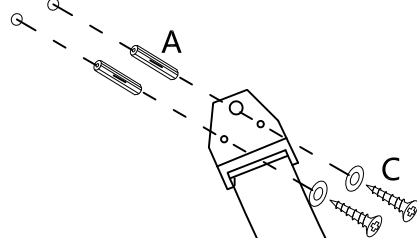

No. A
Quantity:2 Pcs

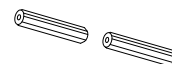

No. C
Quantity:2 Sets



OPTION 2:

STEP 1

WALL

728mm

DRILL HOLES OF $\varnothing 6 \times D35\text{mm}$

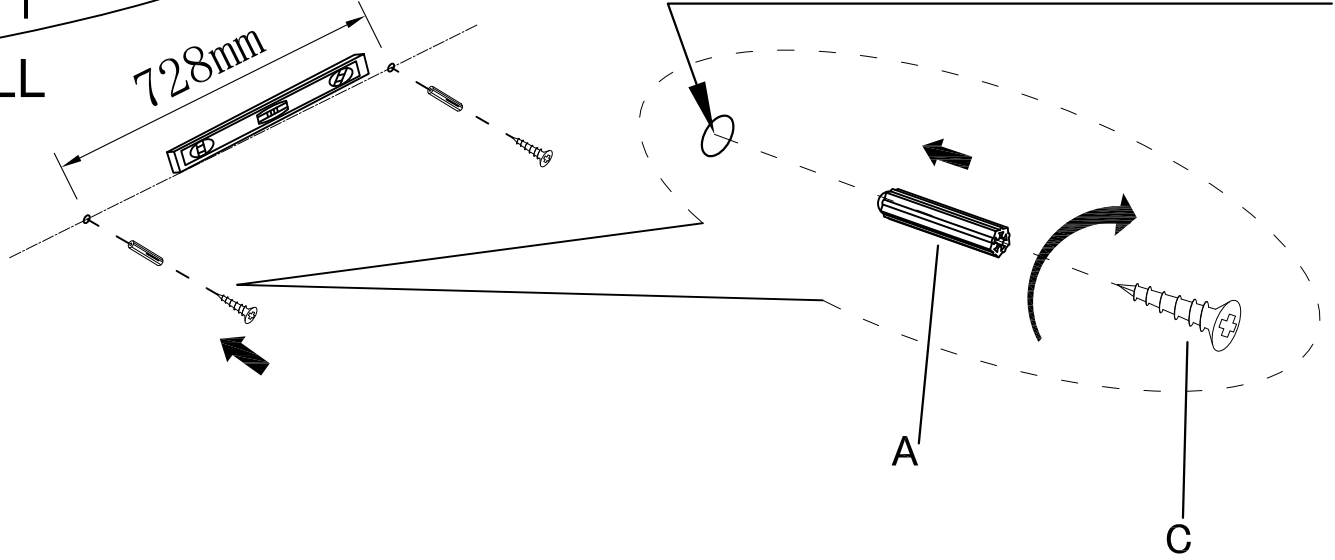

No. A

Quantity: 2 Pcs

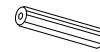

No. C

Quantity: 2 Pcs



STEP 2

WALL

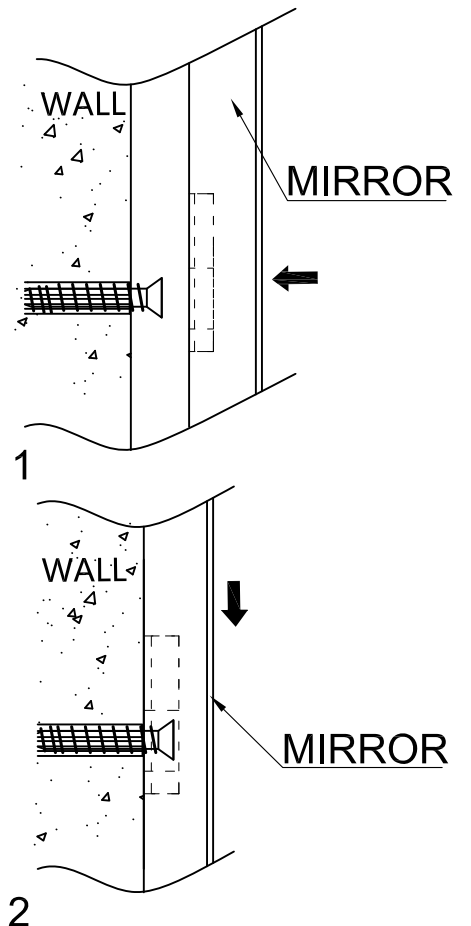
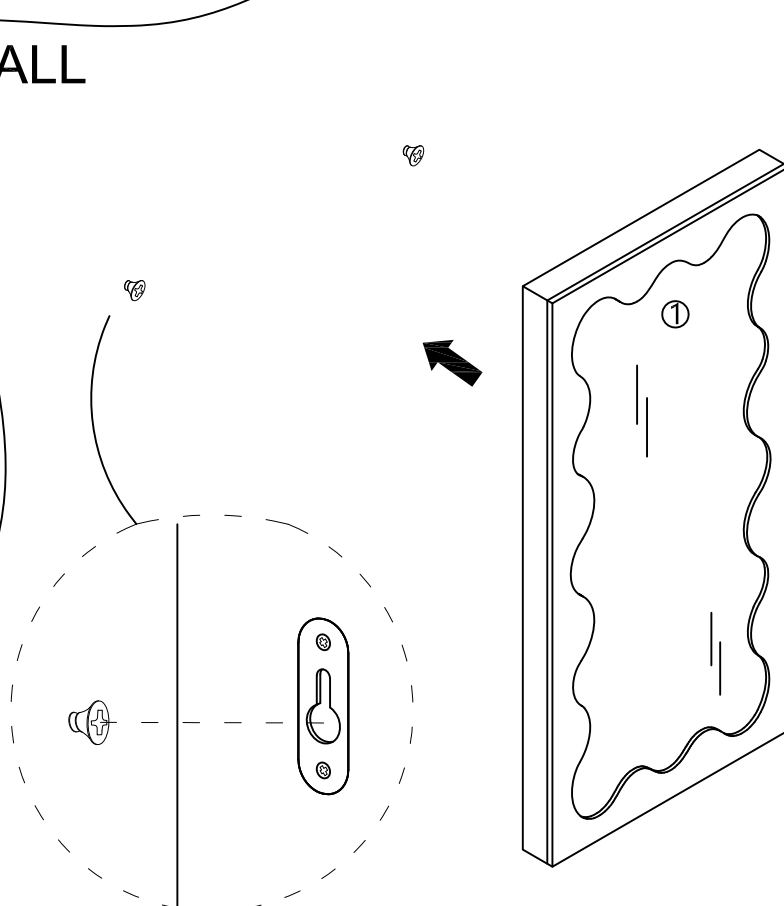

STEP 3

WALL

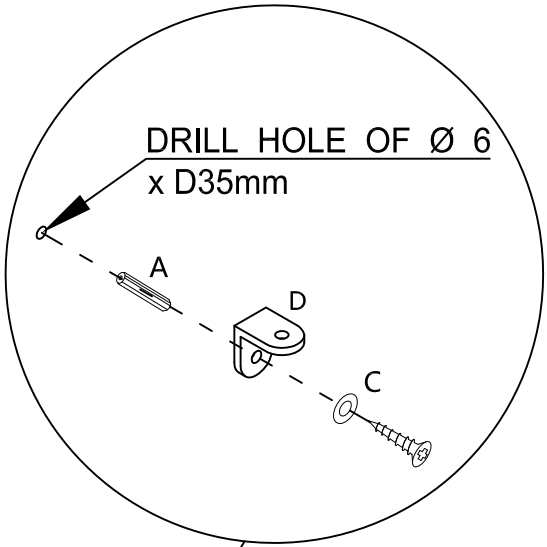
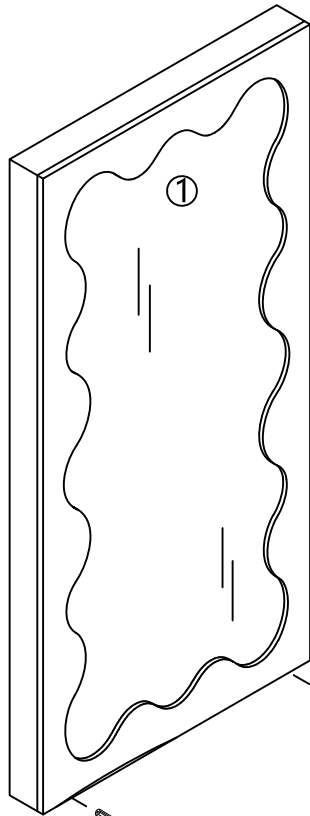

No. A

Quantity:2 Pcs



No. C

Quantity:2 Sets

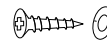

No. D

Quantity:2 Pcs



lifely.com.au

Great job. You're done!

Don't forget to share how it looks in
your space and tag us on Instagram.

@lifelyhome #homewithlifely!