

Assembly Instructions

Sorrento Series

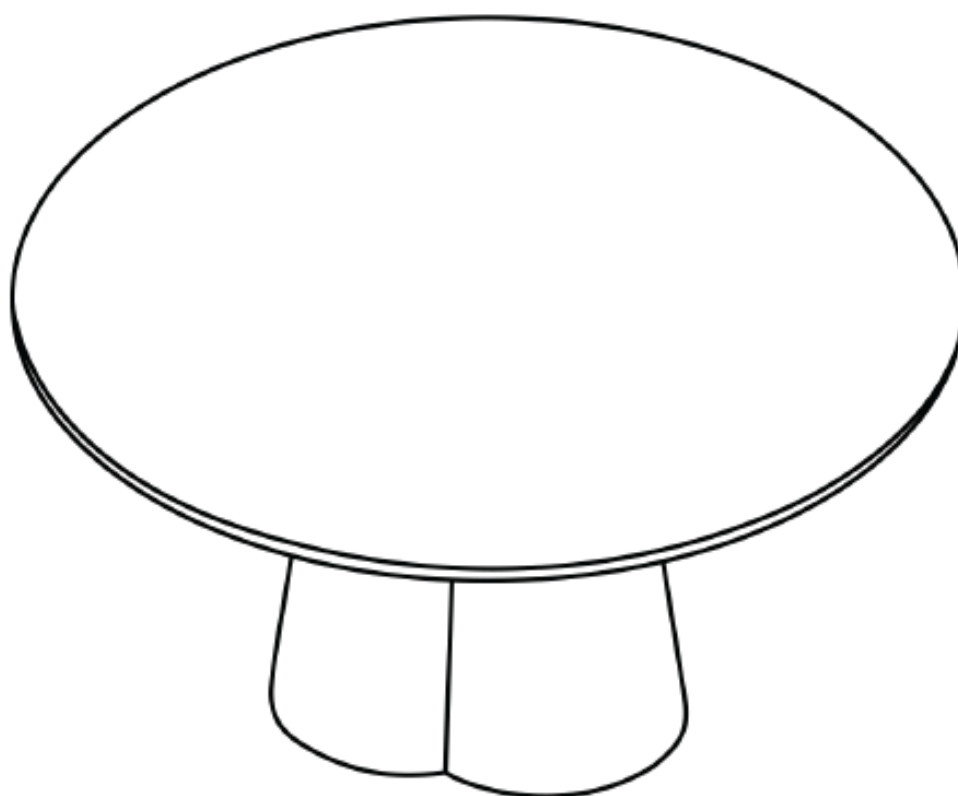

Lifely*

Product Code

SRT-DT-WHT / SRT-DT-BLK Sorrento Dining Table

Dimensions(W x D x H)

1500*1500*750mm

Important

Please read through instruction carefully
Before assembly and keep for future reference.
For our full catalogue of assembly instructions,
Visit: lifely.com.au/assembly.

Important Tips and Maintenance

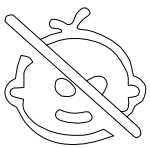

1. Keep children and animals away from working area as smaller parts may cause choking if swallowed.

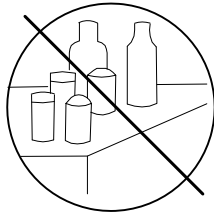

2. Never place liquids or anything damp upon furniture as it will mark. Ensure a coaster or running is beneath.

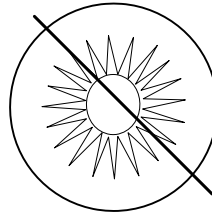

3. To avoid fading, keep furniture out of direct sunlight.

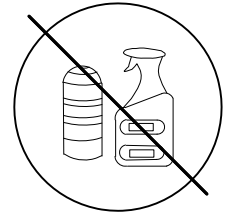

4. Never use ammonia based cleaning products as it will damage the finish.

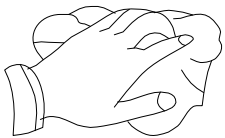

5. Use a soft or dry cloth when wiping or cleaning surfaces.

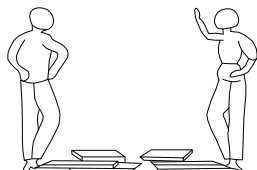

6. Two person are required.

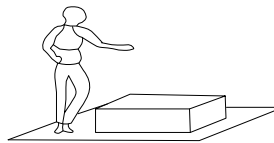

7. Lay a soft matt down to protect the furniture piece before and during assembly.

So your relationship is strong. But is it flat-pack furniture strong? Unless you're an aerospace engineer, assembling furniture can be slightly stressful. We recommend meditating quietly, pouring yourself a herbal tea (or slightly less herbal wine) and tackling things one step at a time. If you feel a passive aggressive remark coming on, try a compliment instead. E.g. "You're so good looking."

This 6-step assembly should take around 20 minutes with an Allen key-or 12 minutes with an electric drill.

Designed for everyday

Component Hardware are in box 1
Please check you have all the fittings
part or tools are listed in below.

No. A
Quantity:1 Pcs
Key
5mm



No. B
Quantity:6 Pcs
EVA Pad
Ø25



No. C
Quantity:7 Pcs
Screw
M8*30



Component Panels & part List

Please check you have all the panels
are listed below.

1. Top Panel-----x1 CTN 2/2
2. Middle Fixing Plate-----x1 CTN 2/2
3. Table Foot Seat-----x1 CTN 1/2

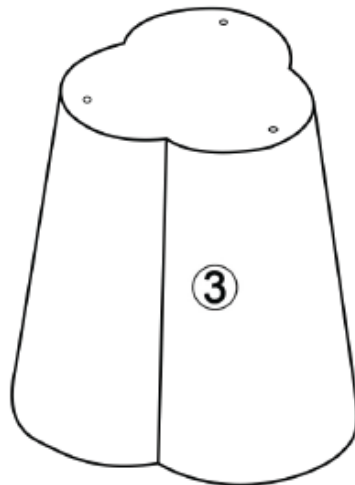
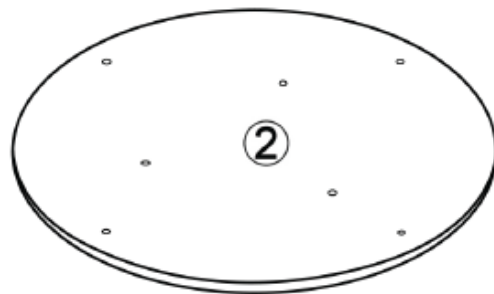
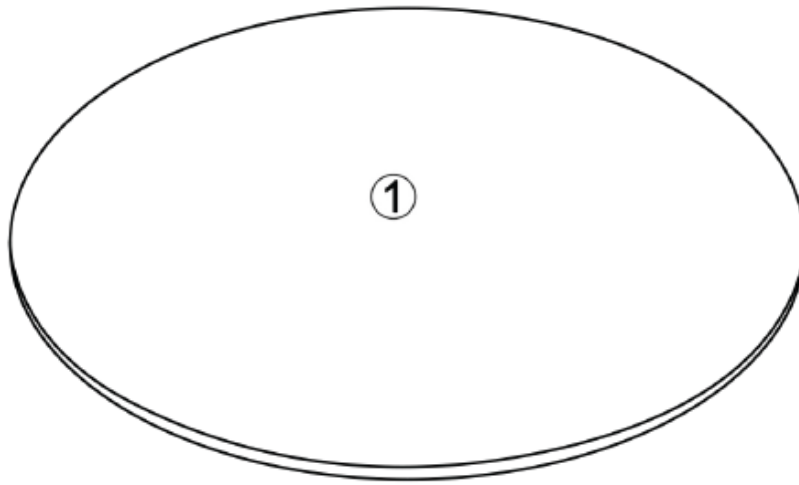

STEP 1

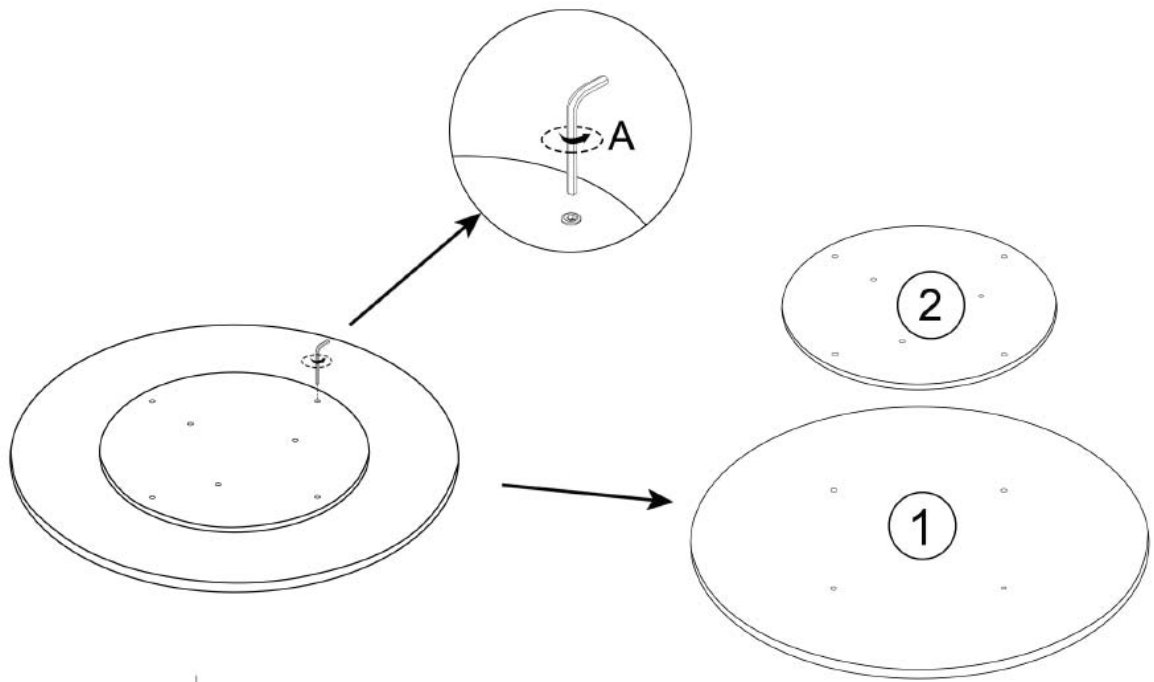

No. A
Quantity:1 Pc



STEP 2

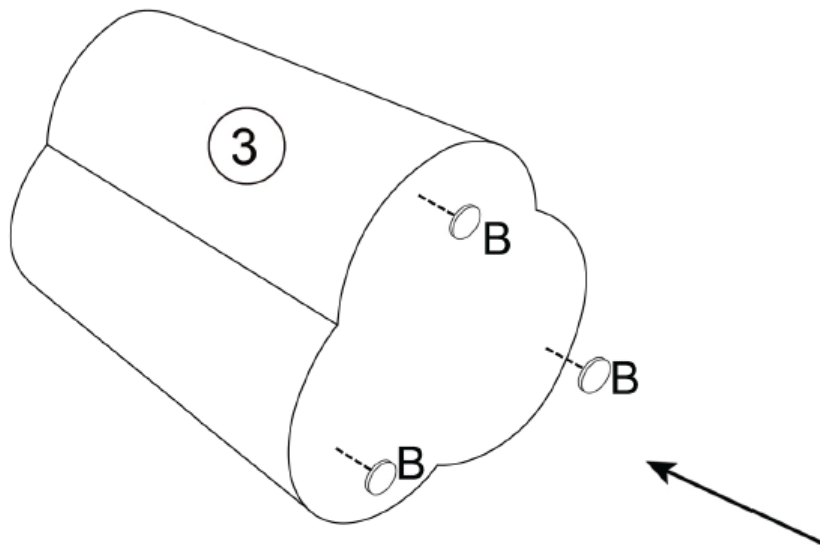

If the bottom is uneven, please add one more pads to adjust

No. B
Quantity:6 Pc



STEP 3

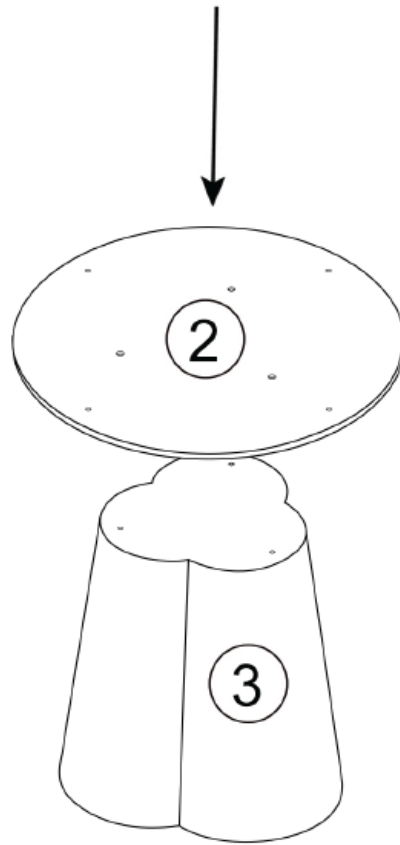

STEP 4

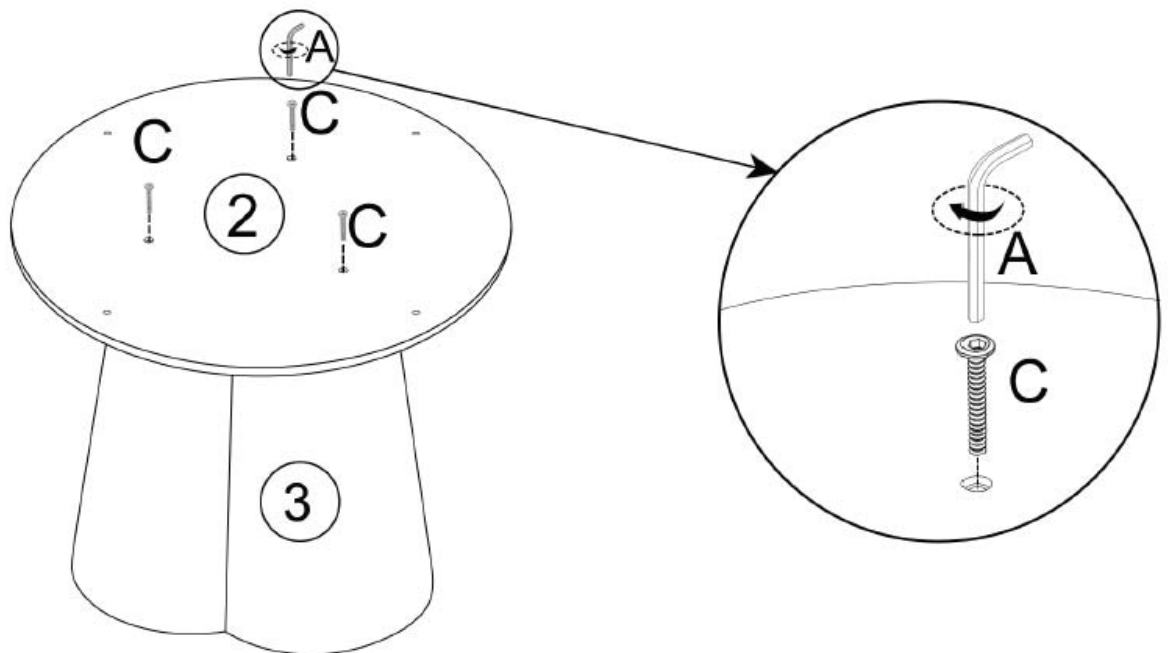

No. A
Quantity: 1 Pc

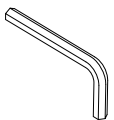

No. C
Quantity: 3 Pcs



STEP 5

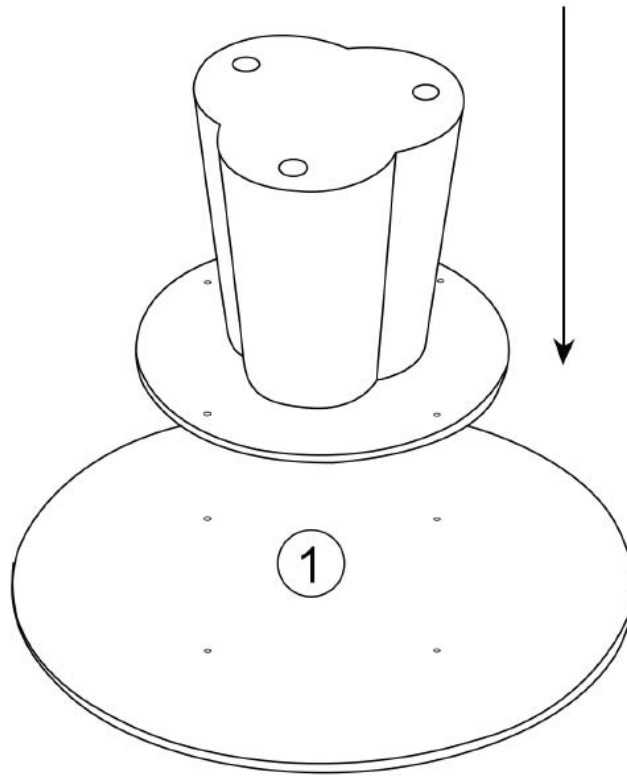

STEP 6

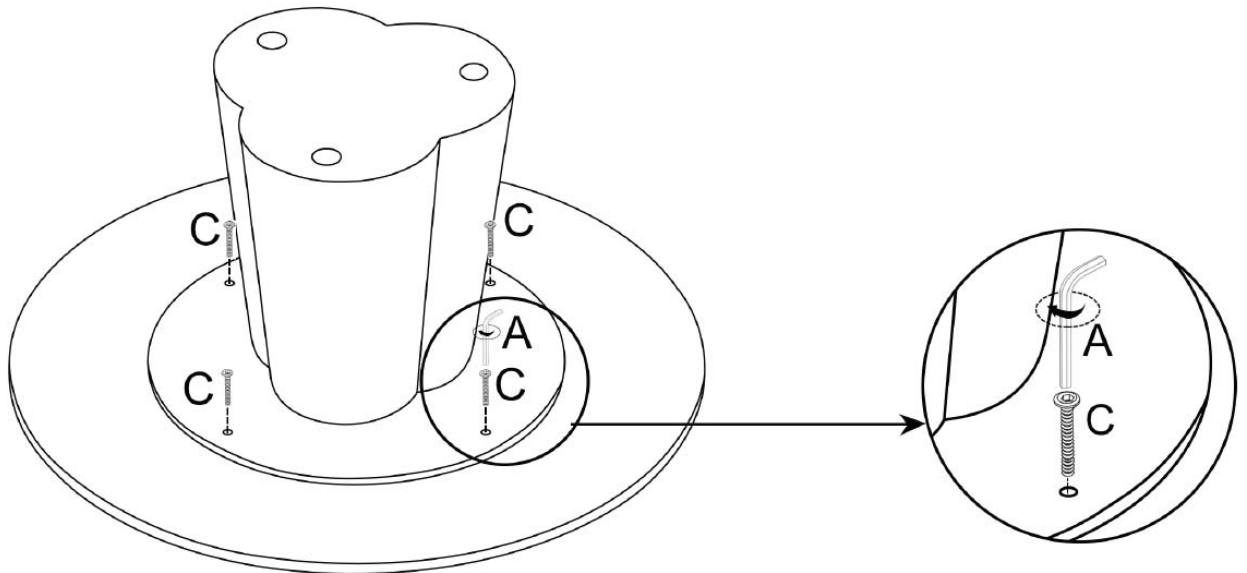

No. A
Quantity: 1 Pc

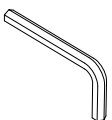

No. C
Quantity: 4 Pcs



lifely.com.au

Great job. You're done!

Don't forget to share how it looks in
your space and tag us on Instagram.

@lifelyhome #homewithlifely!