

Assembly Instructions

Clara Series

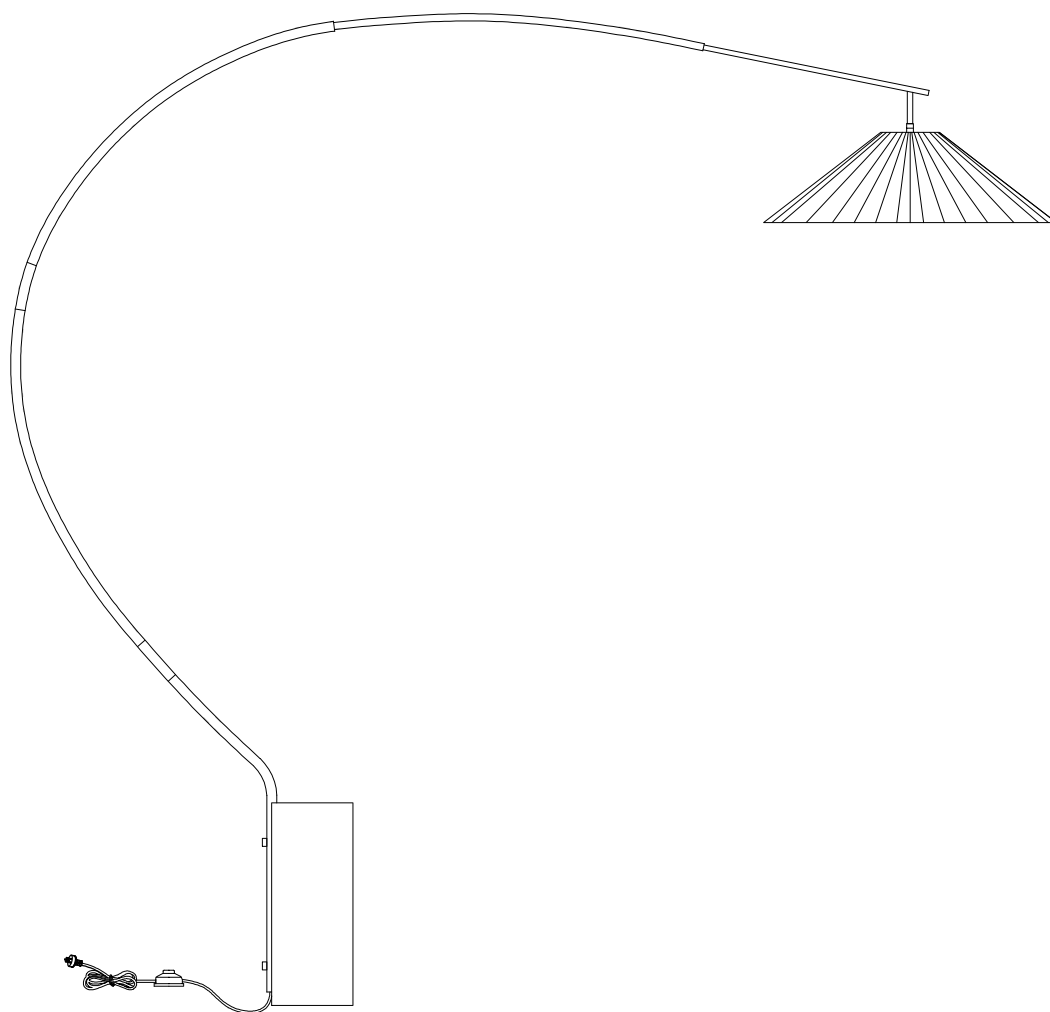

Lifely*

Product Code

CRA-FLAMP Clara Floor Lamp

Dimensions(W x D x H)

2170*650*2200mm

Important

Please read through instruction carefully
Before assembly and keep for future reference.

For our full catalogue of assembly instructions,
Visit: lifely.com.au/assembly.

IMPORTANT SAFETY INSTRUCTIONS:

1. Use an authorized and certified electrician for consultation and installation.
2. To avoid the risk of fire, do not exceed the recommended wattage.
Use 220-240V~50/60 Hz Max. 60 W or LED Max. 7 W E27 Bulb.
3. The manufacturer and distributor accepts no liability for incorrect installation.
4. For indoor use only.
5. Keep away from children.
6. To avoid electric shock, fire, or injury, do not use it if any breakage or distortion is found on the wire or socket, or if the products got wet.

Warnings:

1. Turn-off electricity supply at main circuit panel before installing. Do not connect electricity supply until your floor lamp is fully assembled and installed.
2. All wires are connected. Do not remove the floor lamp from its packaging by pulling on the power cord, as a bad connection may result.
3. To reduce the risk of fire, electrical shock, or personal injury, always turn off the floor lamp and allow it to cool prior to replacing light bulb. Do not touch bulb when fixture is turned on or look directly at light bulb. Keep flammable materials away from light bulb.
4. Deviation from instructions may result in a risk of fire or electric shock.

CARE INSTRUCTIONS:

1. Make sure that the power is turned off and bulb has cooled before handling.
2. Wipe clean with a dry cloth / mild soapy solution. Do not use corrosive cleaners.
3. If the external flexible cable or cord of this luminaire is damaged, it shall be exclusively replaced by the manufacturer or his service agent or a similar qualified person in order to avoid a hazard

ENVIRONMENT:

Special waste handling may be required. Please contact your local authorities for more information.

Important Tips and Maintenance



1. Keep children and animals away from working area as smaller parts may cause choking if swallowed.

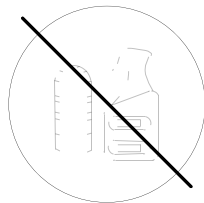

2. Never use ammonia based cleaning products as it will damage the finish.



3. Use a soft dry cloth when wiping or cleaning surfaces.



4. Two person are required.



5. Lay a soft matt down to protect the fixture piece before and during assembly.

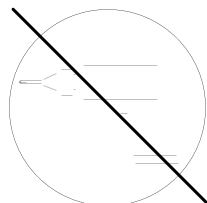

6. NO POWER TOOLS

So your relationship is strong. But is it flat-pack furniture strong? Unless you're an aerospace engineer, assembling furniture can be slightly stressful. We recommend meditating quietly, pouring yourself a herbal tea (or slightly less herbal wine) and tackling things one step at a time. If you feel a passive aggressive remark coming on, try a compliment instead. E.g. "You're so good looking."

This 4-step assembly should take around 15 minutes.

Designed for everyday

Component Hardware is in box 1

**Please check you have all the fittings
part or tools are listed in below.**

No. A (Not Included)

Quantity:1 Pc

E27 Bulbs

φ65*140mm



No. B (Box 1)

Quantity:1 Pc

Allen Key

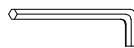

Component Panels & part List

Please check you have all the panels are listed below.

| | | | |
|----|---------------|----|---------|
| 1. | Shade | x1 | CTN 2/3 |
| 2. | connect rod2 | x1 | CTN 1/3 |
| 3. | Connect rod 3 | x1 | CTN 1/3 |
| 4. | Connect rod 4 | x1 | CTN 1/3 |
| 5. | Connect rod 5 | x1 | CTN 1/3 |
| 6. | Connect rod 6 | x1 | CTN 1/3 |
| 7. | Base | x1 | CTN 3/3 |

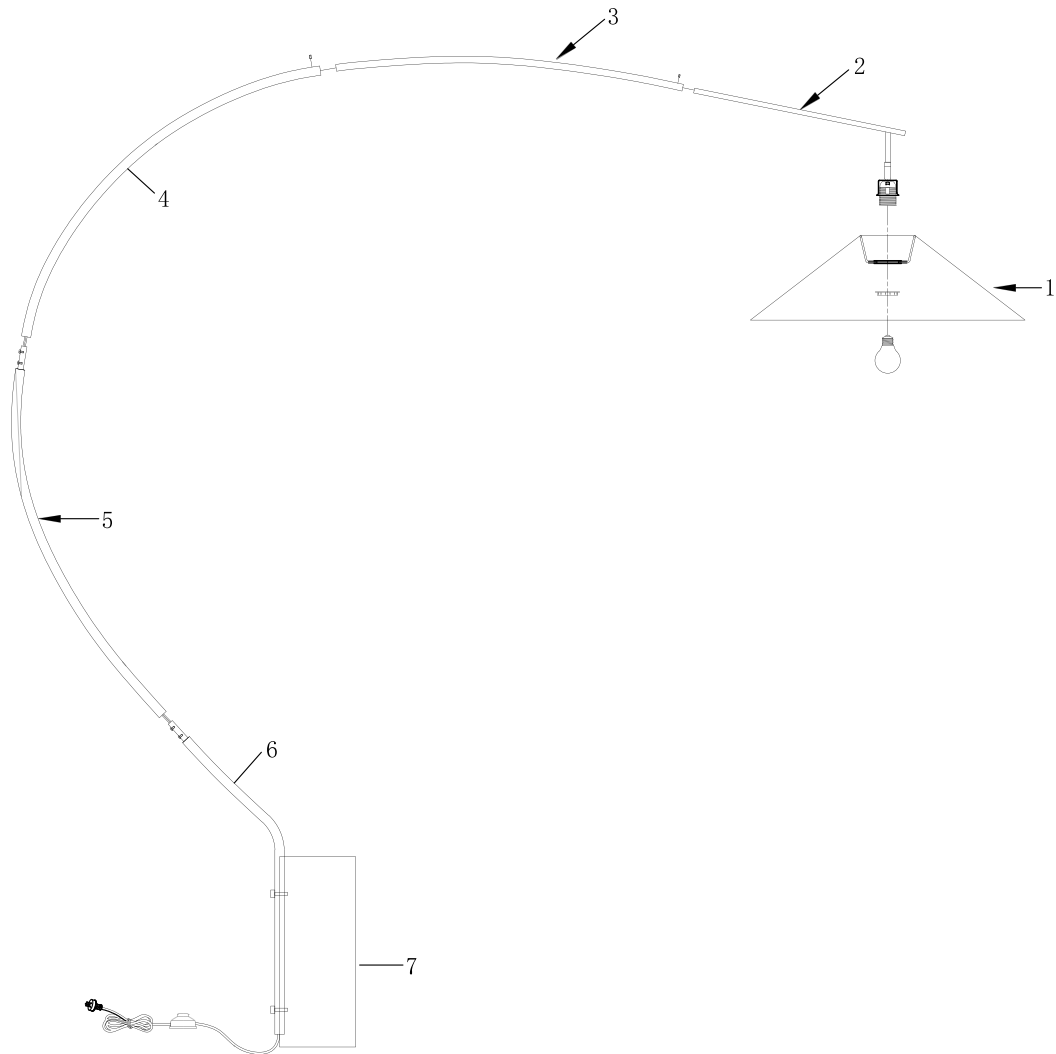

STEP 1

Unscrew the screws on upper of the bending tube 5 and 6, then insert the tube, fasten it back with the screws

please insert the tube at least 10 cm, but less than 30 cm.

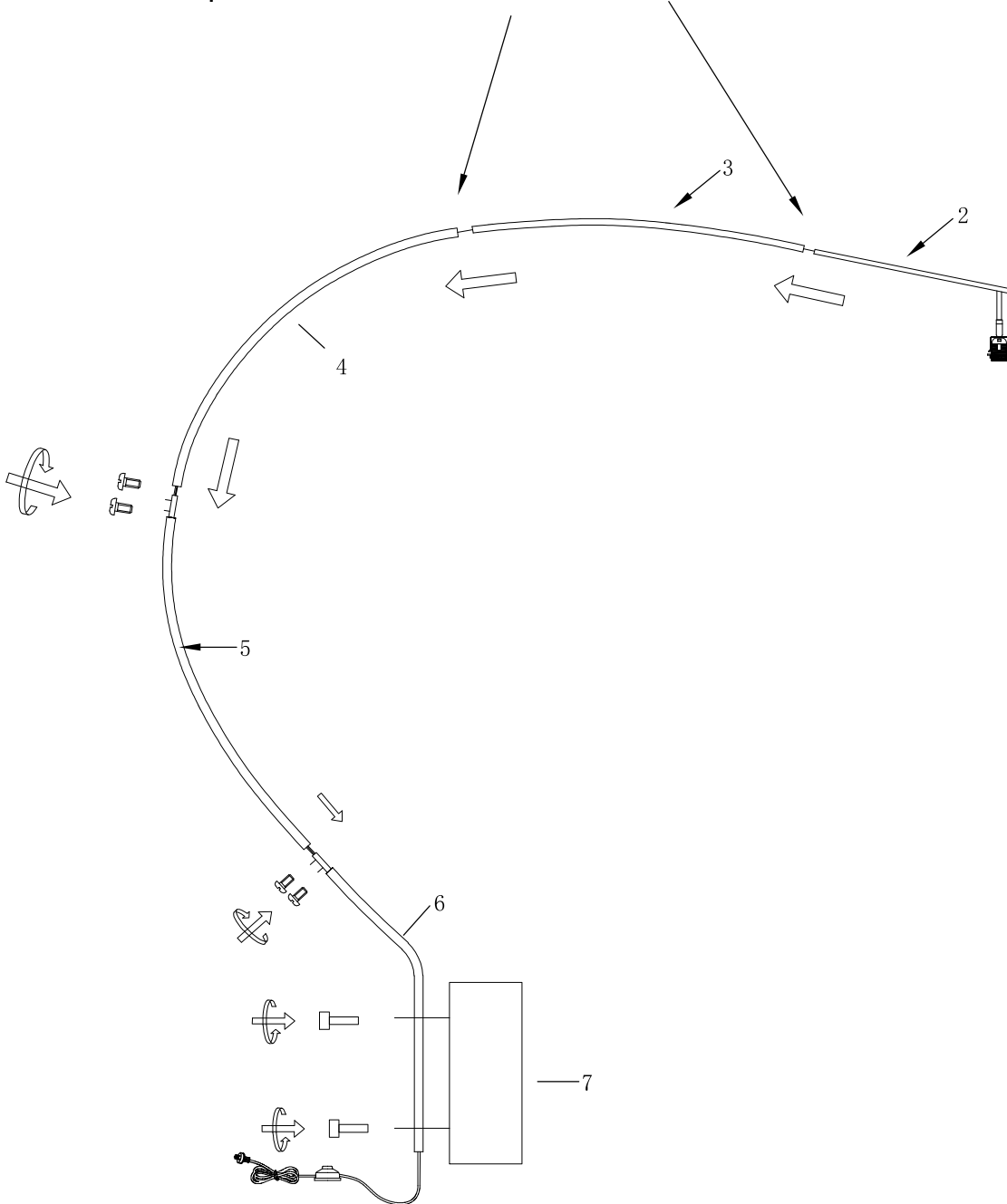

Pull out a bit of the supply cord, when assembling the 6 and 7, please fasten 60% of the screws to ensure they are aligned with all holes, then fasten 100%.

STEP 2

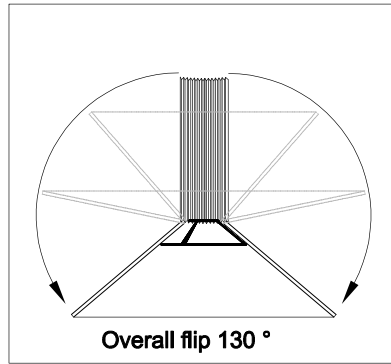

Open the shade follow the drawing shows after get it from box.

Please twist out the plastic ring on the lamp-holder, then install the shade and tighten the plastic ring back.

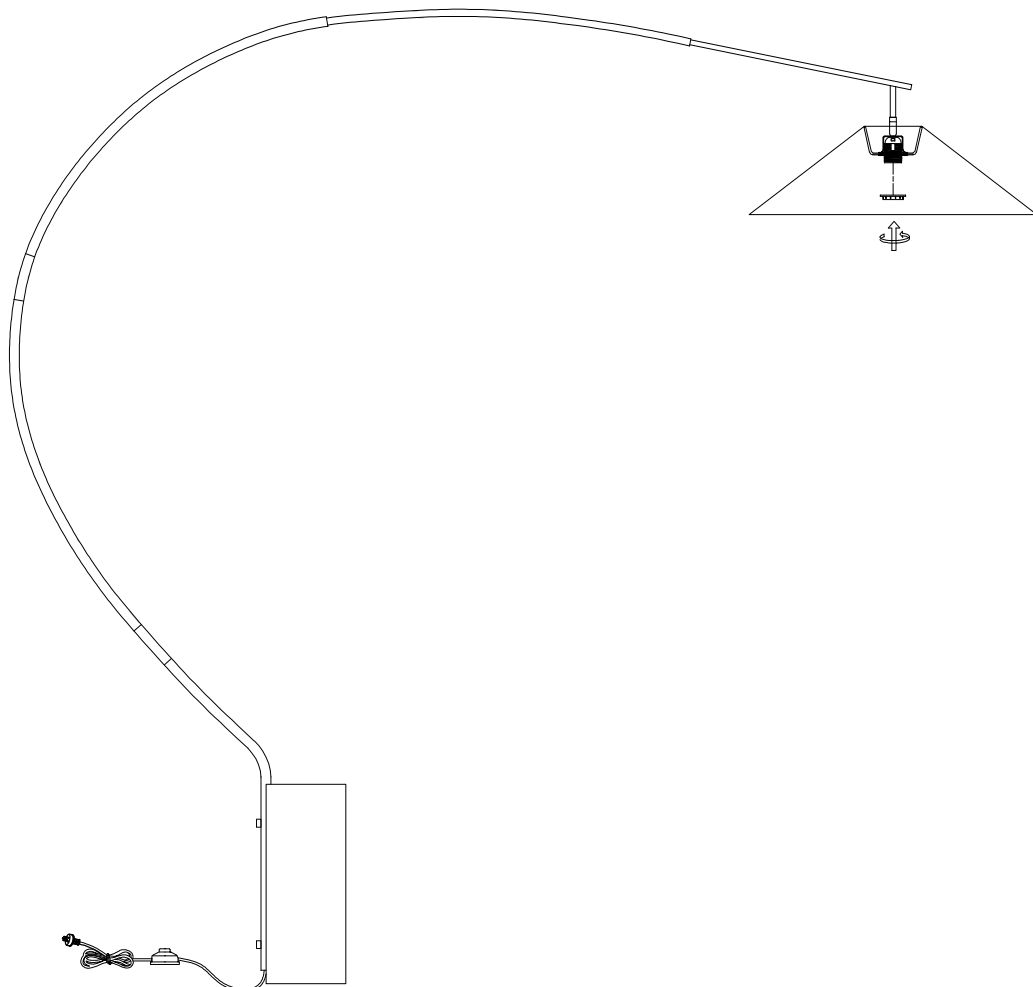

STEP 3

Install the bulb.

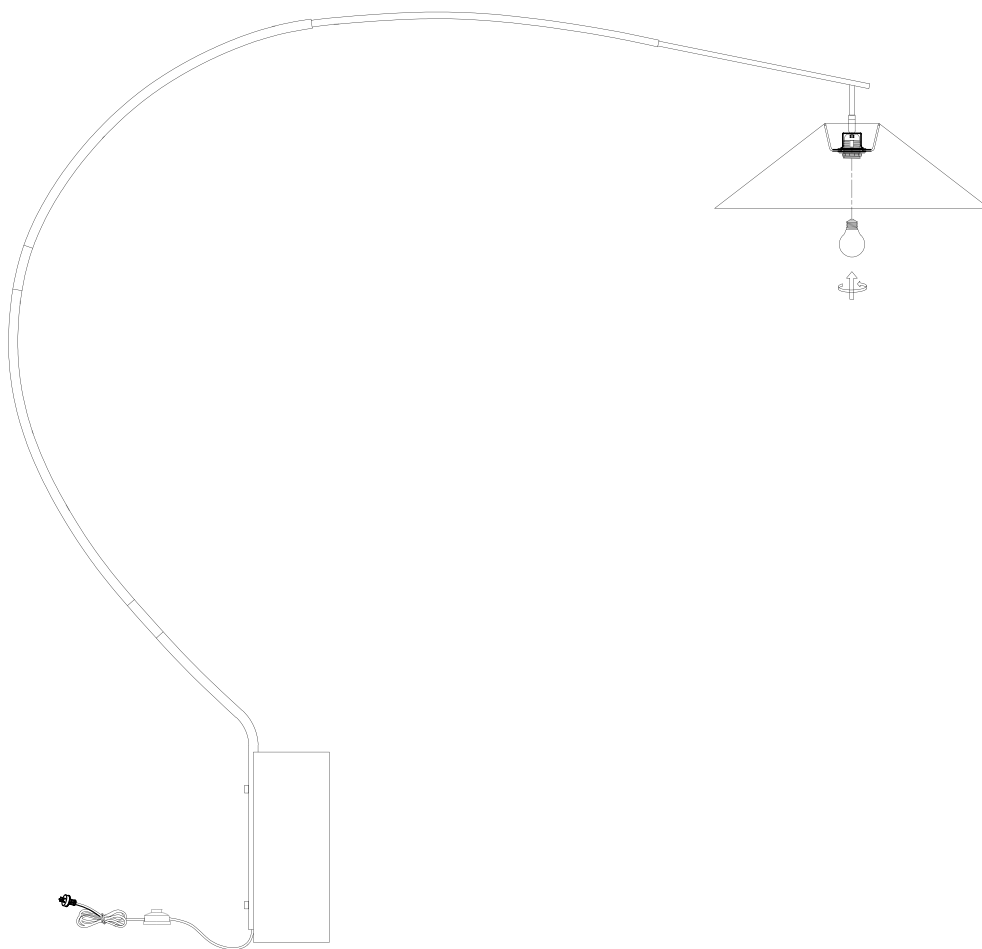

STEP 4

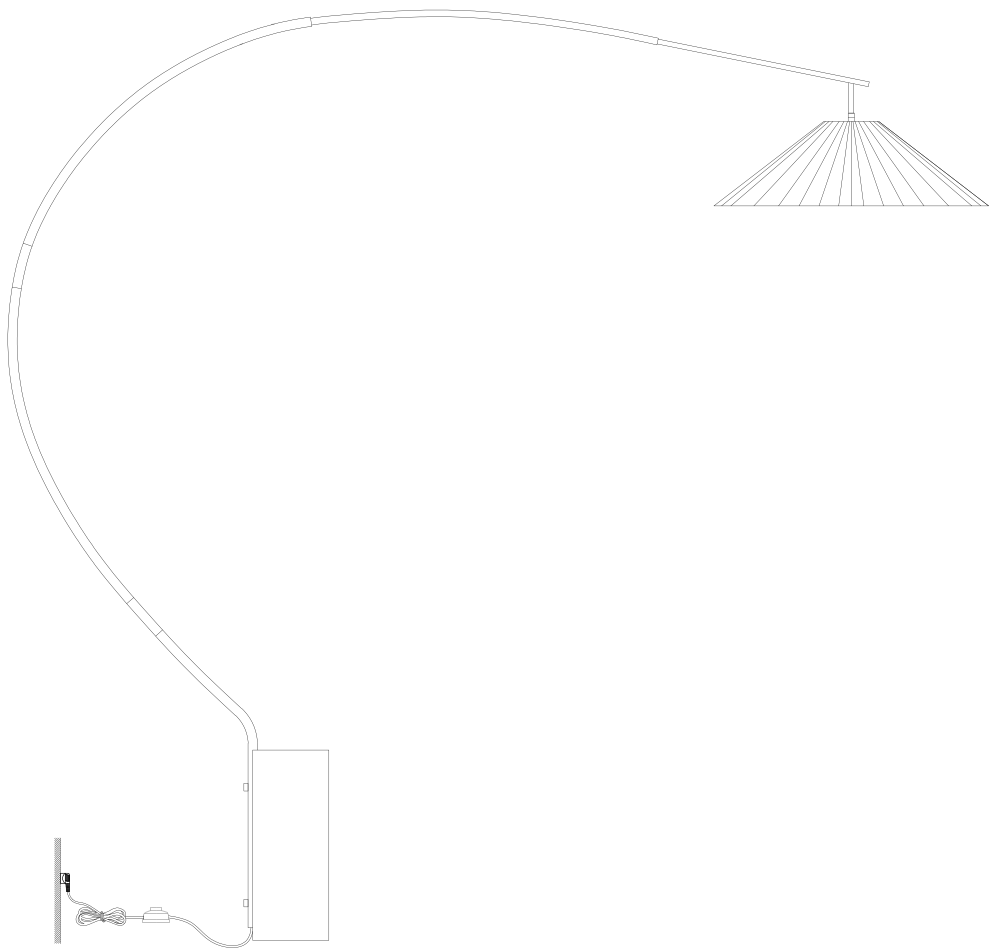

lifely.com.au

Great job. You're done!

Don't forget to share how it looks in
your space and tag us on Instagram.

@lifelyhome
#homewithlifely!